

Czy matematyka potrzebna jest artystom?

dr Zdzisław Pogoda, prof. UJ

MATEMATYKA

www.mwo.usz.edu.pl w obiektywie



Akademia Pedagogiki Specjalnej
im. Marii Grzegorzewskiej
1922–2022

Czy matematyka
potrzebna jest artystom?

dr Zdzisław Pogoda, prof. UJ



Perspektywa

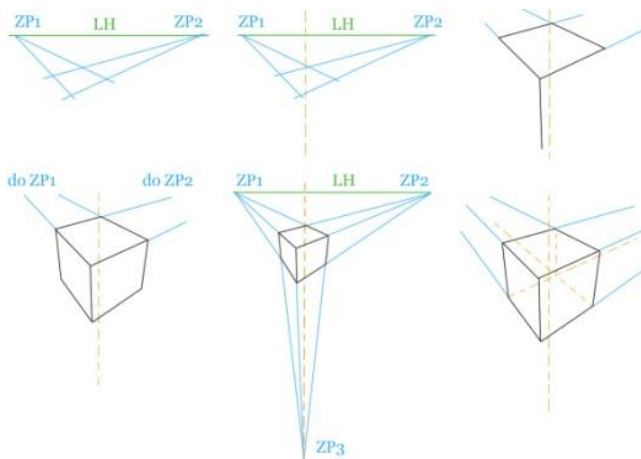
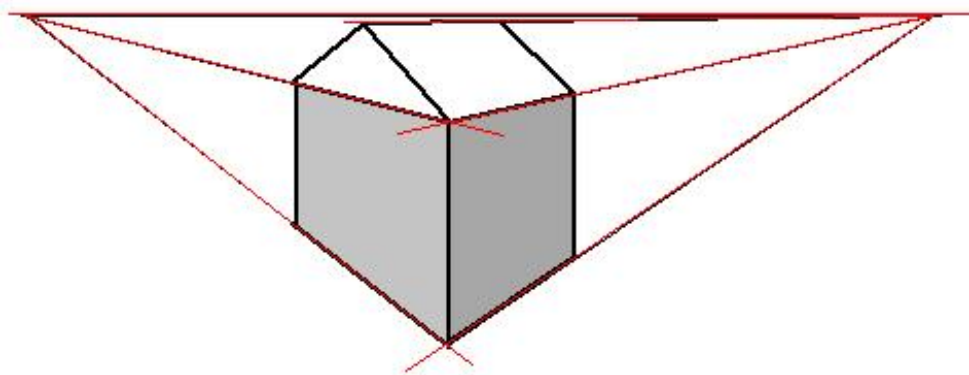
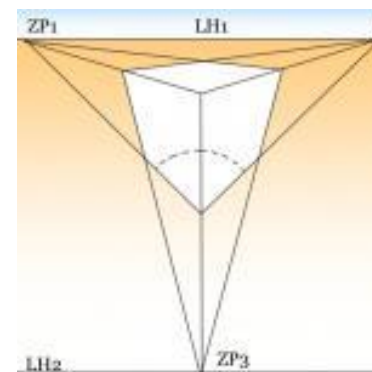
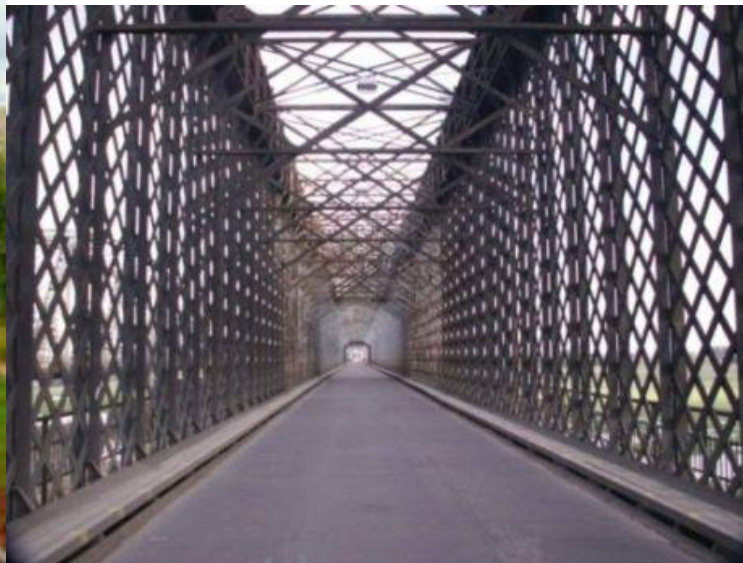



Crivelli -Zwiastowanie



Albrecht Dürer



Luca Pacioli i Divina Proportione

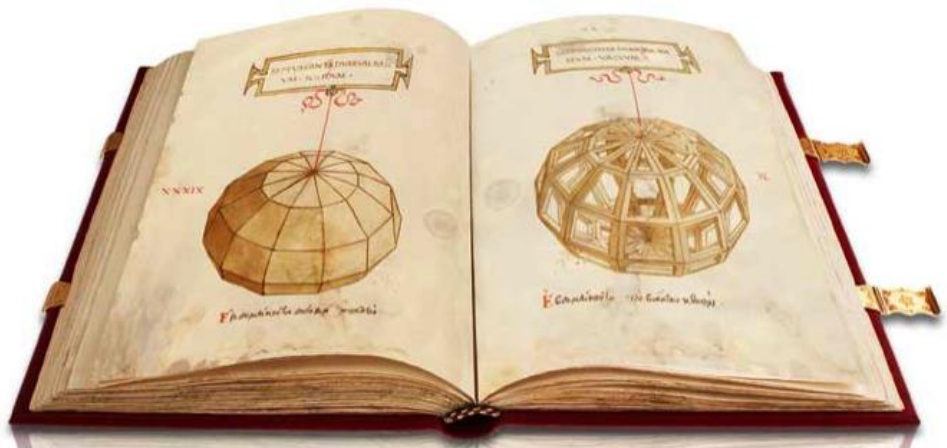
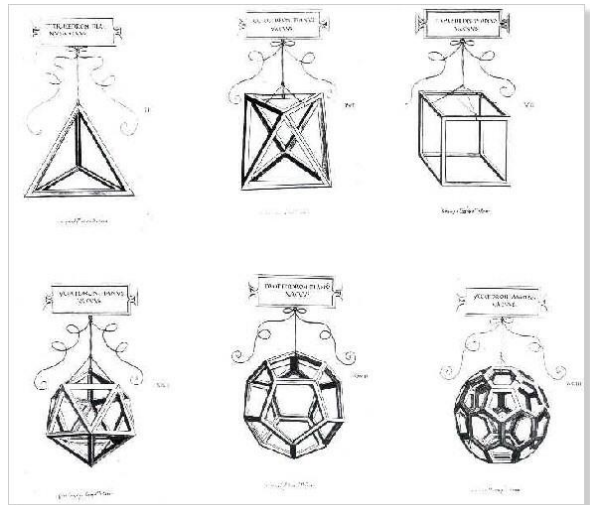
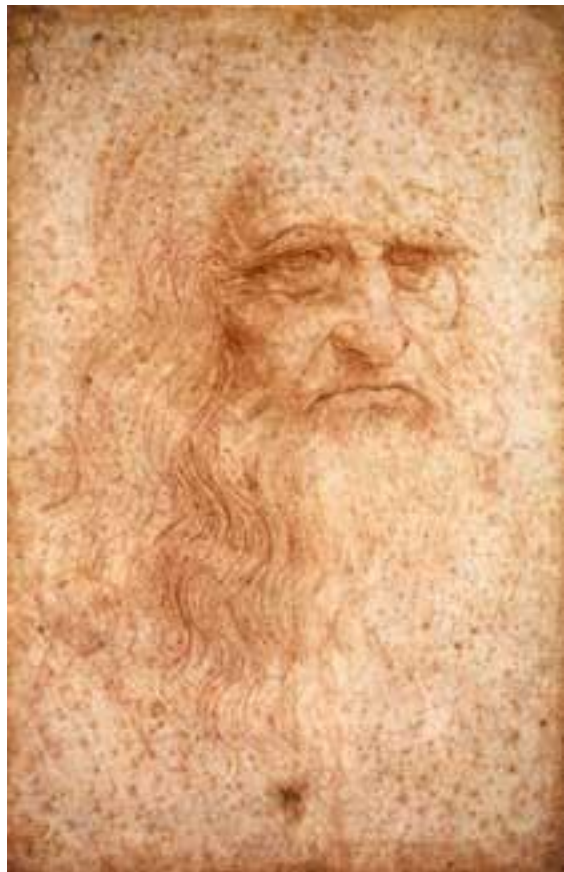

Desargues (z lewej na obrazie) i jego twierdzenie

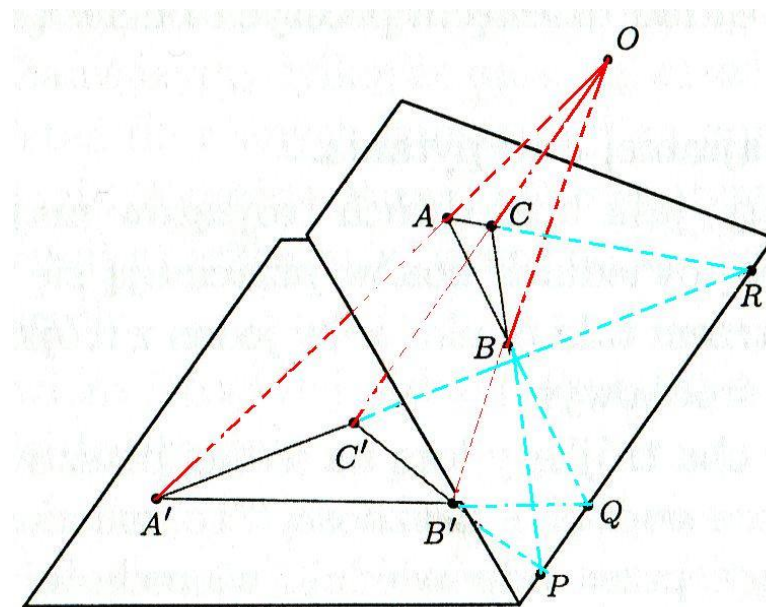
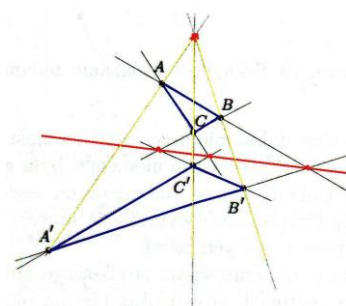
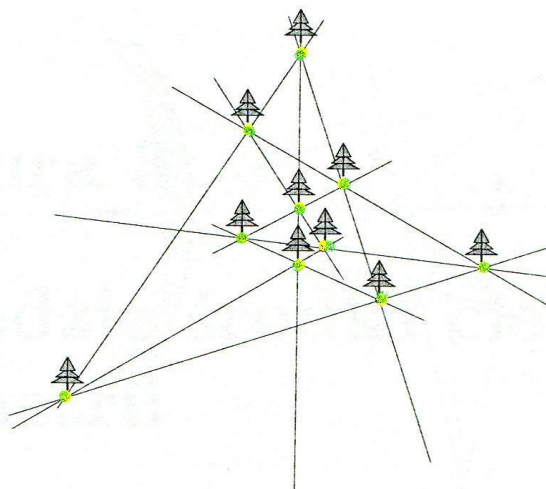
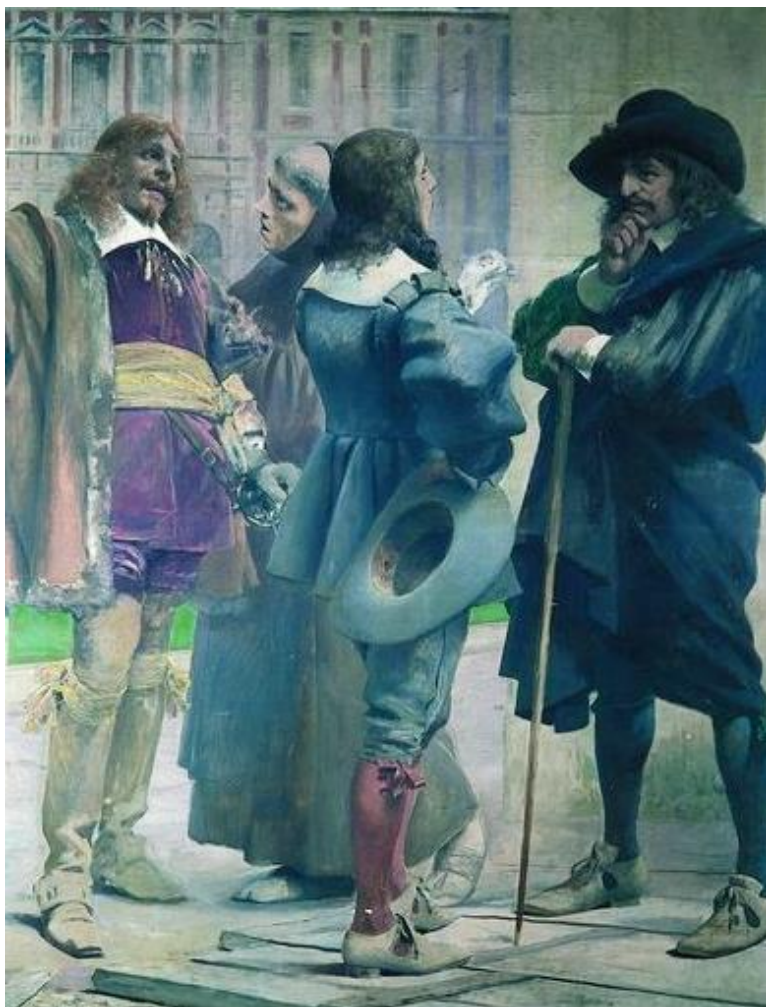

Salvador Dali

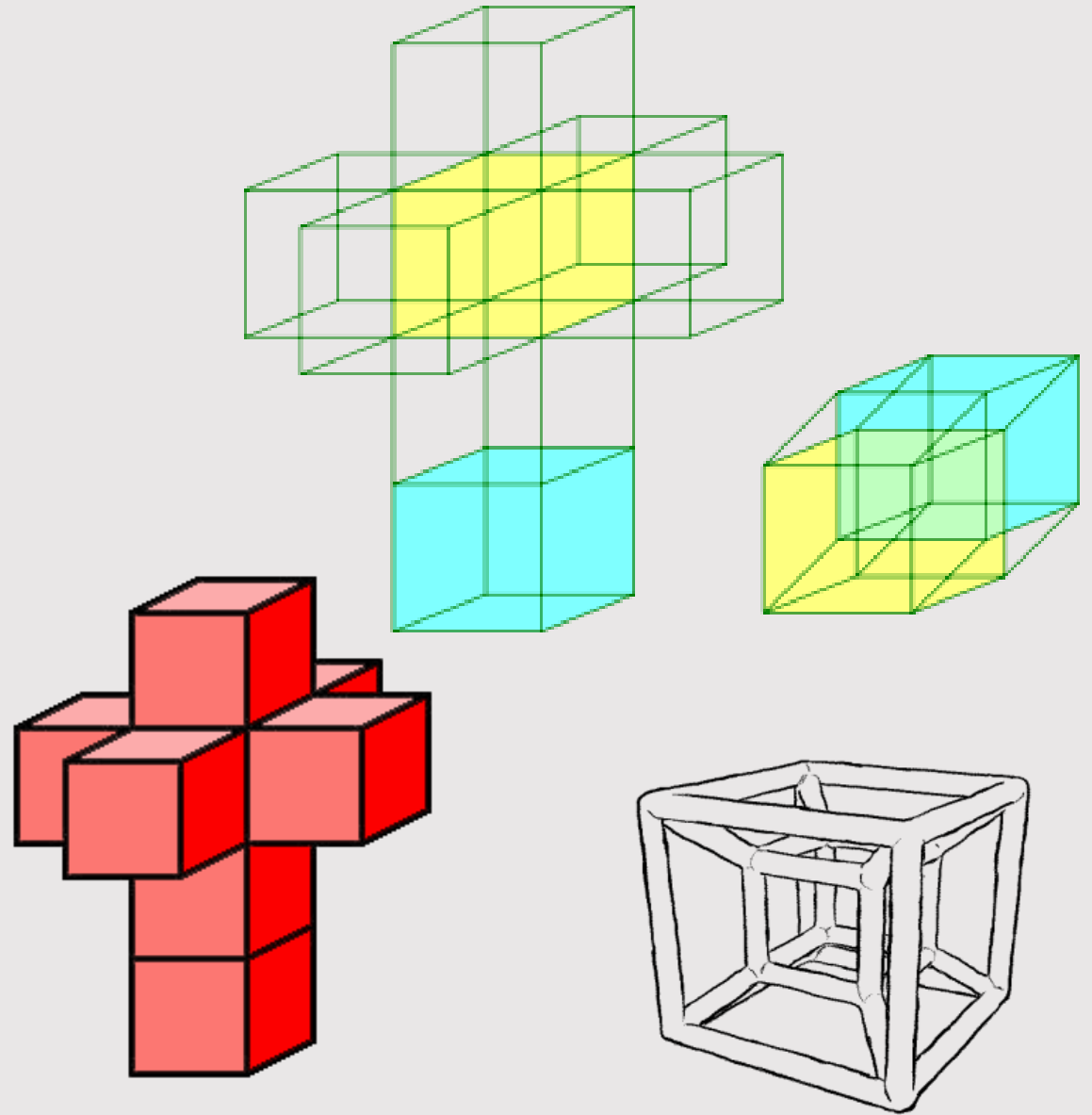
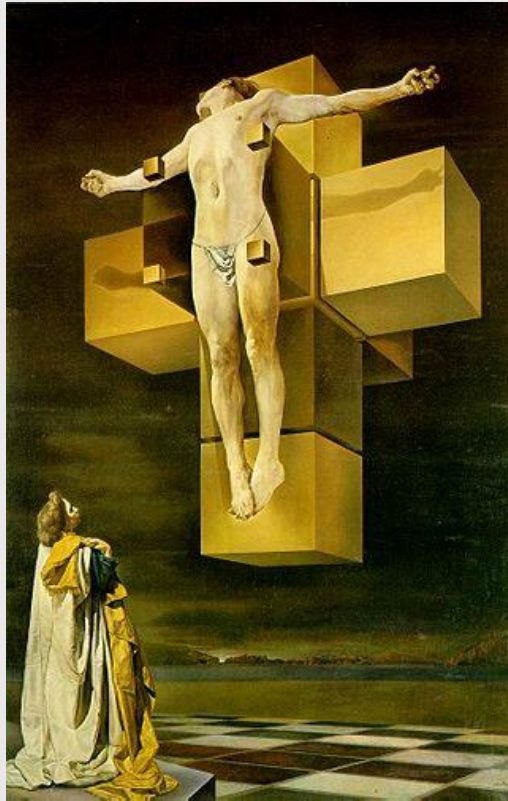

Maurits Cornelis Escher

17.06.1898 – 27.03.1972



Wielościany

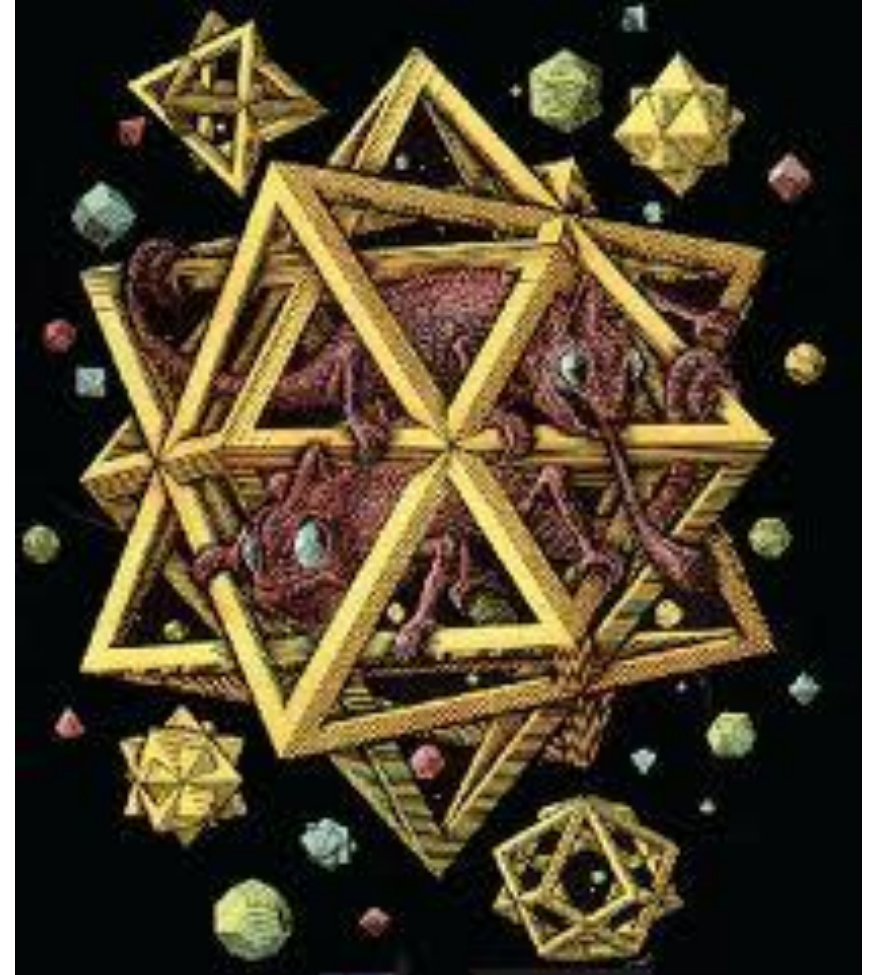
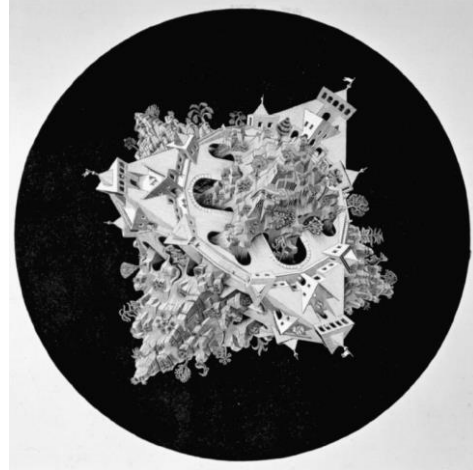
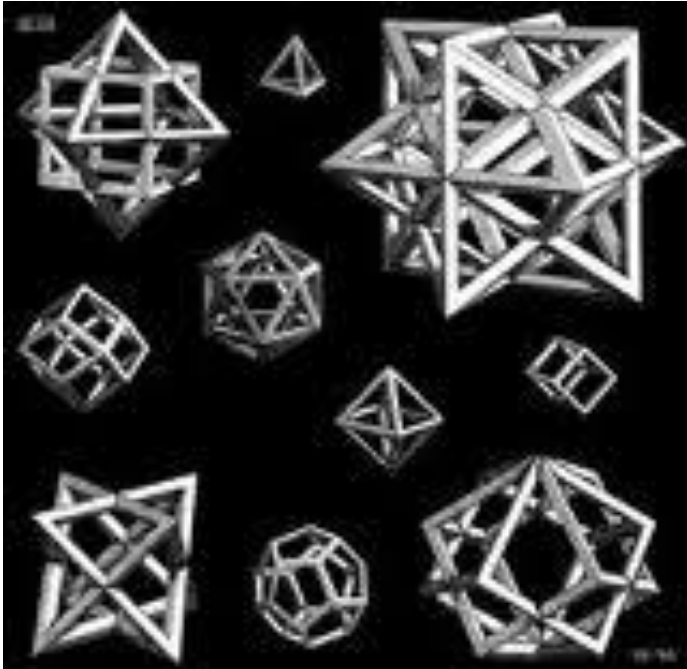

Wstęgi Möbiusa

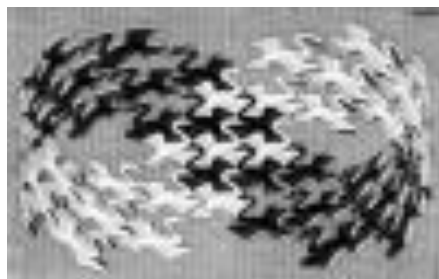

Анатолий Фоменко

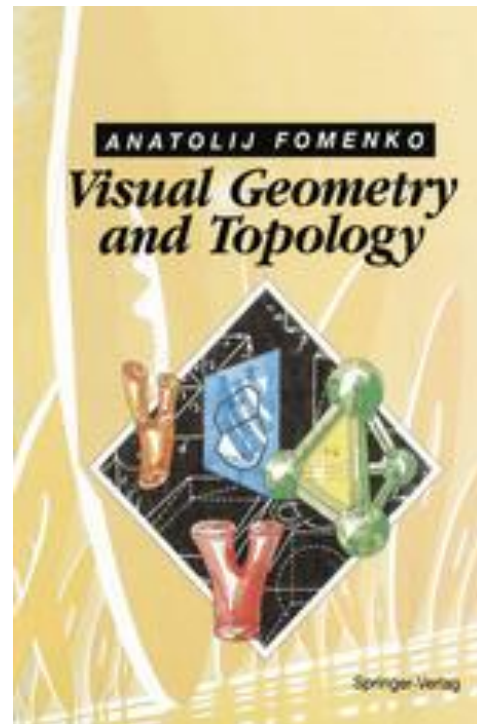

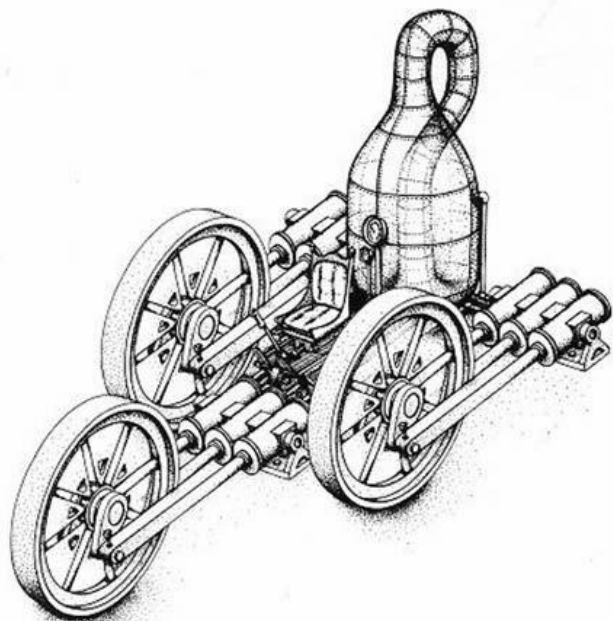
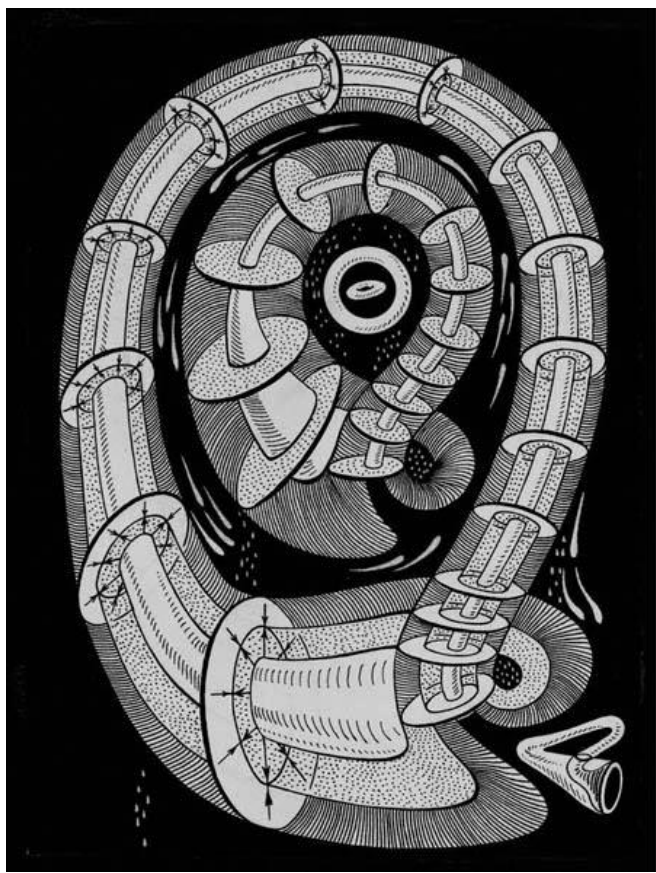

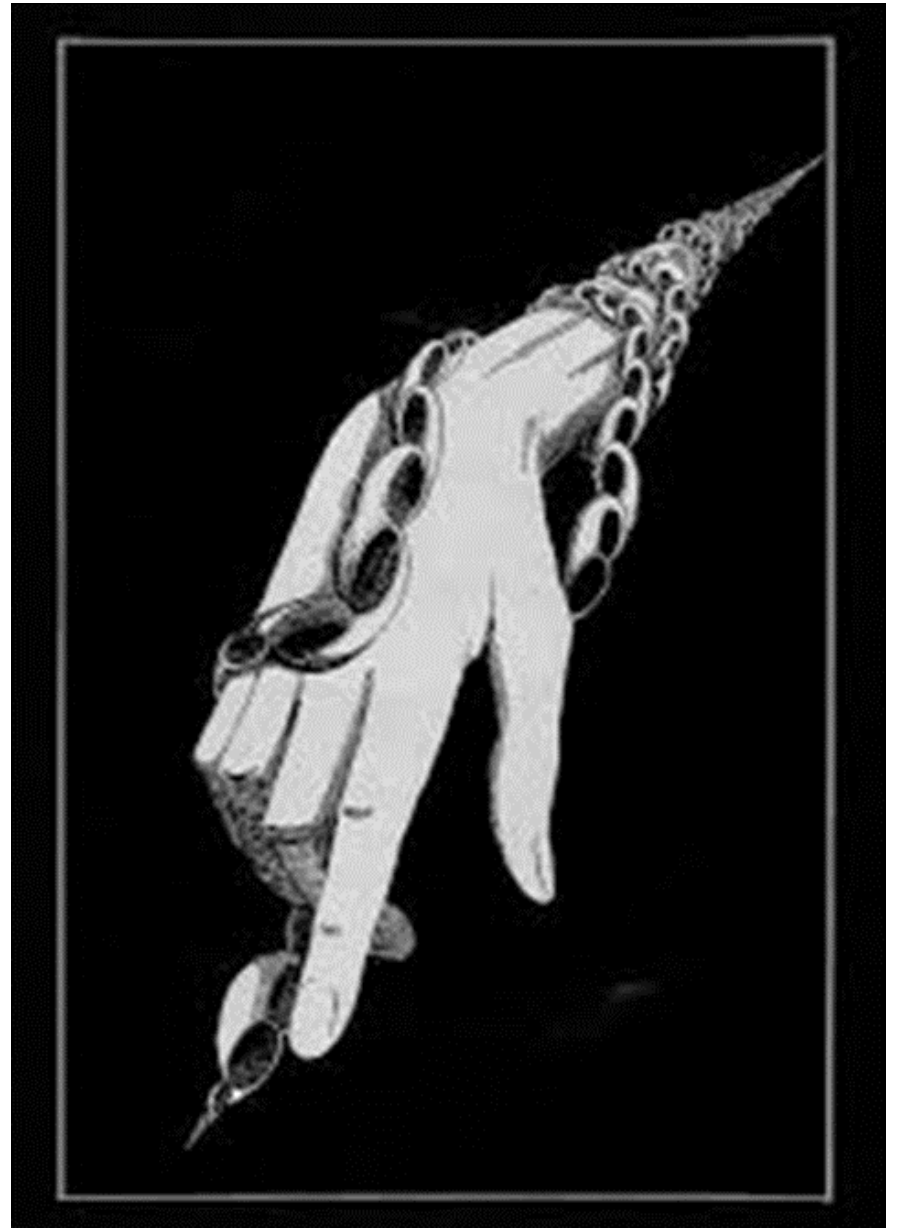

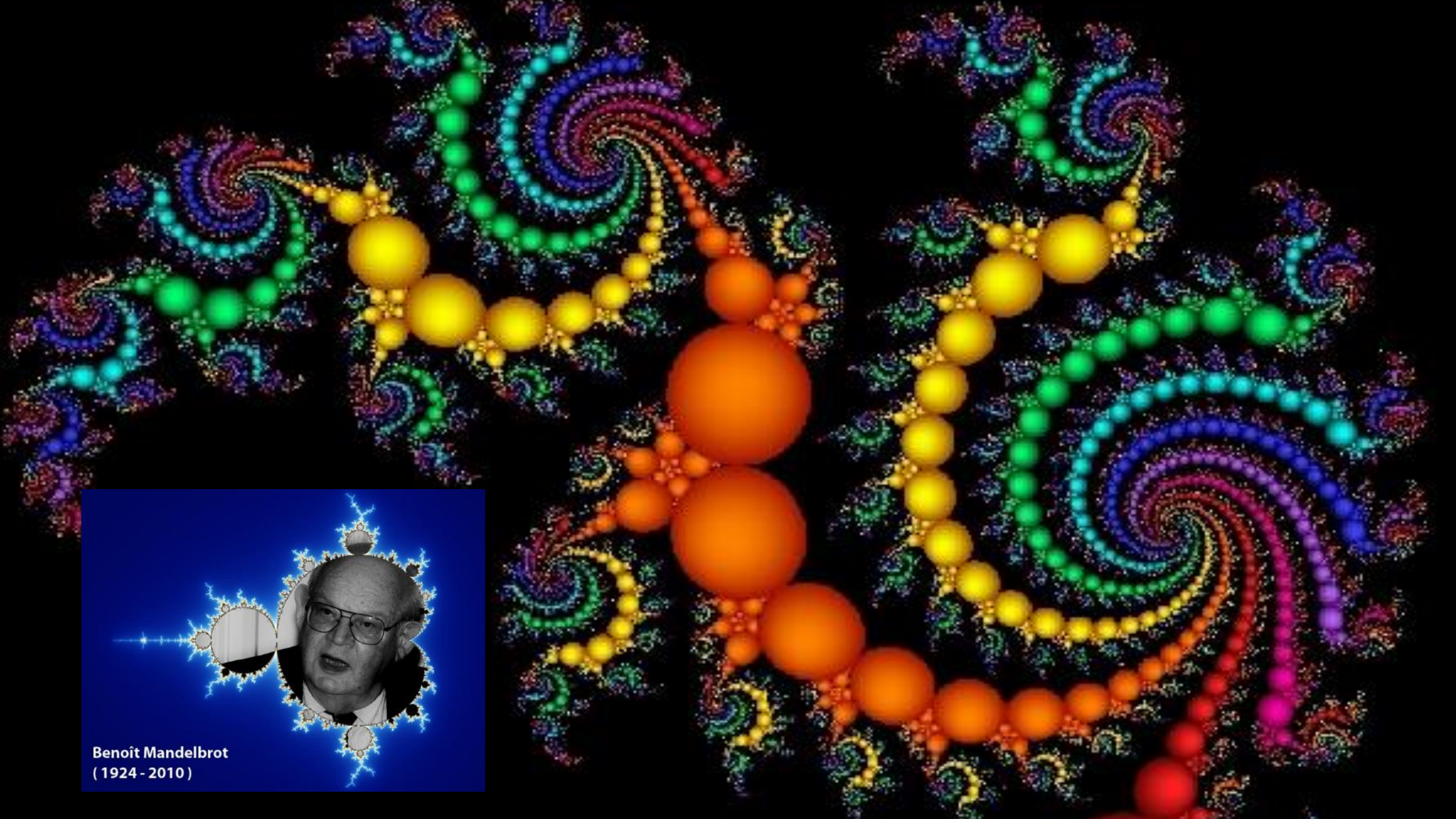

Benoit Mandelbrot
(1924 - 2010)



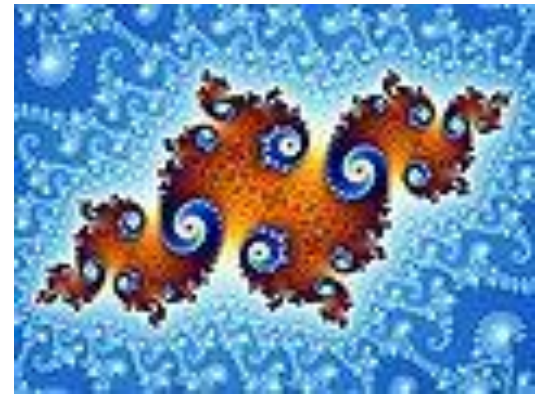
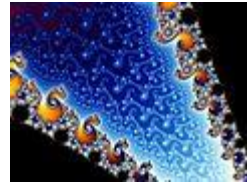
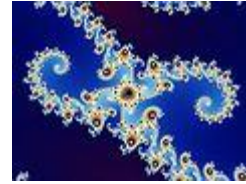
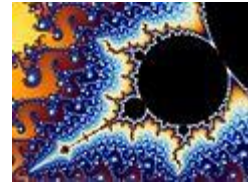
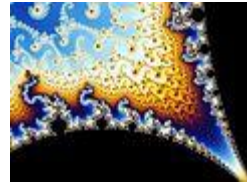
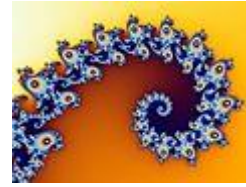
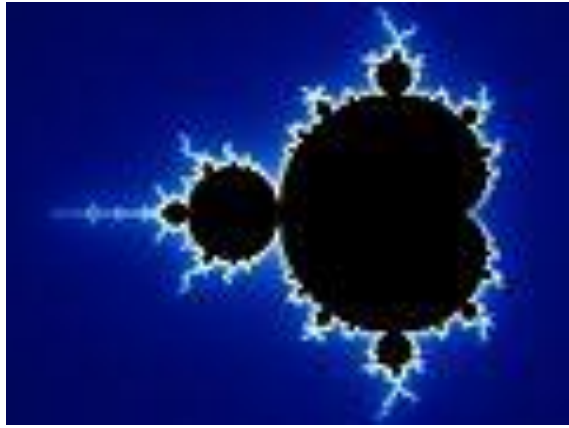



Fałszywa perspektywa

